



**ELECTROSTATIC SENSITIVE DEVICE**  
OBSERVE HANDLING PRECAUTIONS

MITSUBISHI RF POWER MOS FET

# RD06HHF1

Silicon MOSFET Power Transistor 30MHz,6W

## DESCRIPTION

RD06HHF1 is a MOS FET type transistor specifically designed for HF RF power amplifiers applications.

## FEATURES

- High power gain:  
Pout>6W, Gp>16dB @Vdd=12.5V,f=30MHz

## APPLICATION

For output stage of high power amplifiers in HF band mobile radio sets.

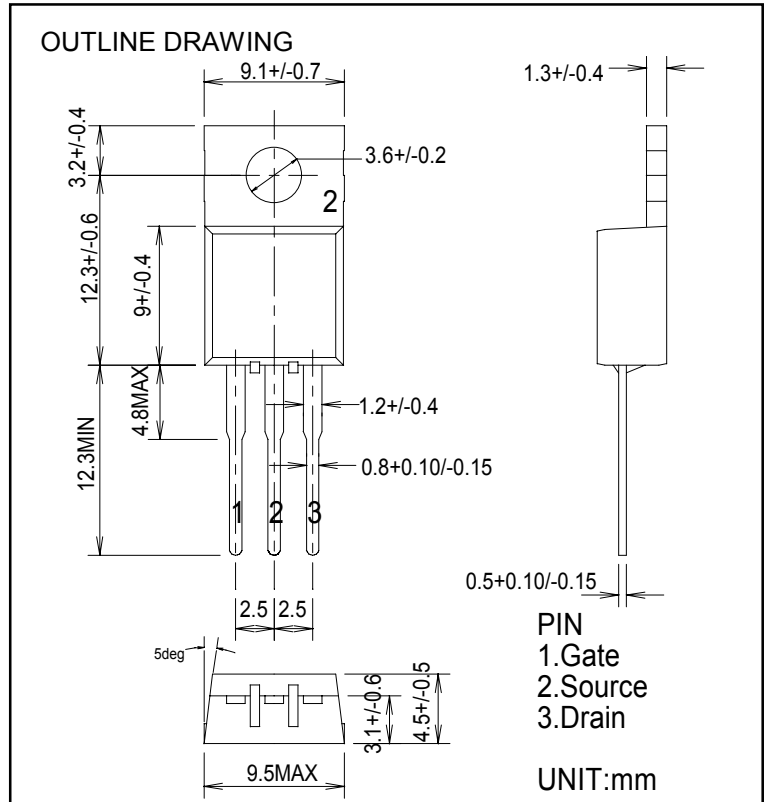

## ABSOLUTE MAXIMUM RATINGS

(Tc=25°C UNLESS OTHERWISE NOTED)

SYMBOL	PARAMETER	CONDITIONS	RATINGS	UNIT
V <sub>DSS</sub>	Drain to source voltage	V <sub>GS</sub> =0V	50	V
V <sub>GSS</sub>	Gate to source voltage	V <sub>DS</sub> =0V	+/- 20	V
P <sub>ch</sub>	Channel dissipation	T <sub>c</sub> =25°C	27.8	W
P <sub>in</sub>	Input power	Z <sub>g</sub> =Z <sub>l</sub> =50Ω	0.3	W
I <sub>D</sub>	Drain current	-	3	A
T <sub>ch</sub>	Channel temperature	-	150	°C
T <sub>stg</sub>	Storage temperature	-	-40 to +150	°C
R <sub>th j-c</sub>	Thermal resistance	junction to case	4.5	°C/W

Note 1: Above parameters are guaranteed independently.

## ELECTRICAL CHARACTERISTICS

(Tc=25°C, UNLESS OTHERWISE NOTED)

SYMBOL	PARAMETER	CONDITIONS	LIMITS			UNIT
			MIN	TYP	MAX.	
I <sub>DSS</sub>	Zero gate voltage drain current	V <sub>DS</sub> =17V, V <sub>GS</sub> =0V	-	-	10	μA
I <sub>GSS</sub>	Gate to source leak current	V <sub>GS</sub> =10V, V <sub>DS</sub> =0V	-	-	1	μA
V <sub>TH</sub>	Gate threshold Voltage	V <sub>DS</sub> =12V, I <sub>DS</sub> =1mA	1.9	-	4.9	V
P <sub>out</sub>	Output power	V <sub>DD</sub> =12.5V, P <sub>in</sub> =0.15W,	6	10	-	W
η <sub>D</sub>	Drain efficiency	f=30MHz, I <sub>dq</sub> =0.5A	55	65	-	%
	Load VSWR tolerance	V <sub>DD</sub> =15.2V, P <sub>o</sub> =6W(Pin Control) f=30MHz, I <sub>dq</sub> =0.5A, Z <sub>g</sub> =50Ω Load VSWR=20:1(All Phase)	No destroy			-

Note : Above parameters , ratings , limits and conditions are subject to change.



ELECTROSTATIC SENSITIVE DEVICE  
OBSERVE HANDLING PRECAUTIONS

MITSUBISHI RF POWER MOS FET

# RD06HHF1

Silicon MOSFET Power Transistor 30MHz,6W

## TYPICAL CHARACTERISTICS

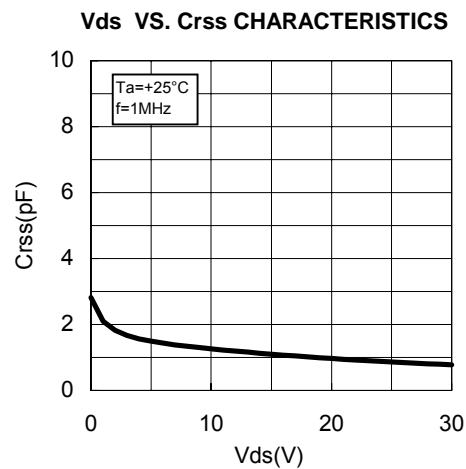
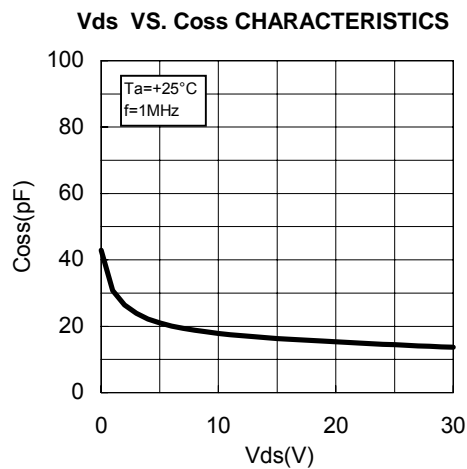
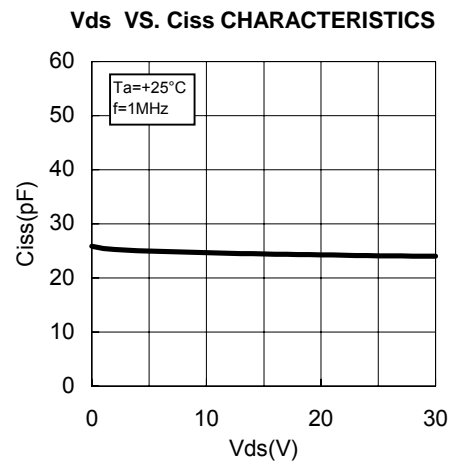
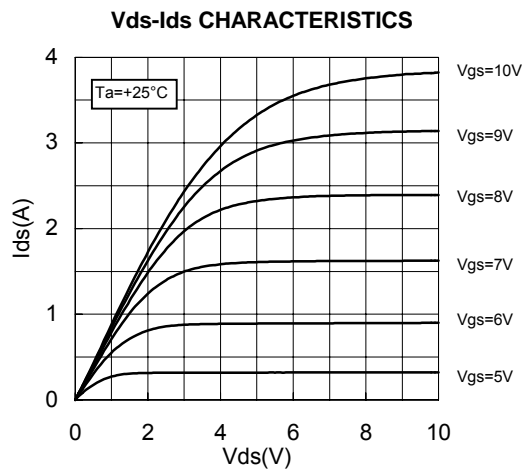
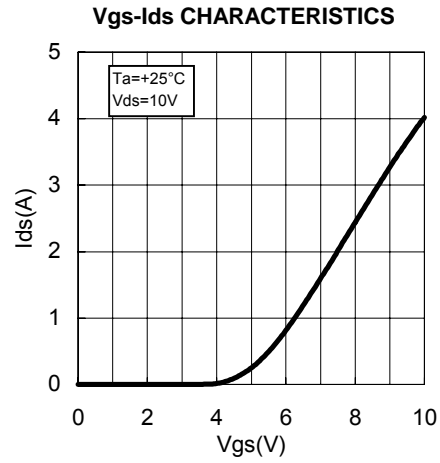
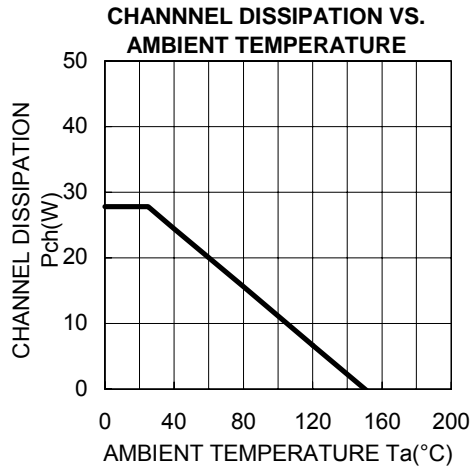



ELECTROSTATIC SENSITIVE DEVICE  
OBSERVE HANDLING PRECAUTIONS

MITSUBISHI RF POWER MOS FET

# RD06HHF1

Silicon MOSFET Power Transistor 30MHz,6W

## TYPICAL CHARACTERISTICS

Pin-Po CHARACTERISTICS

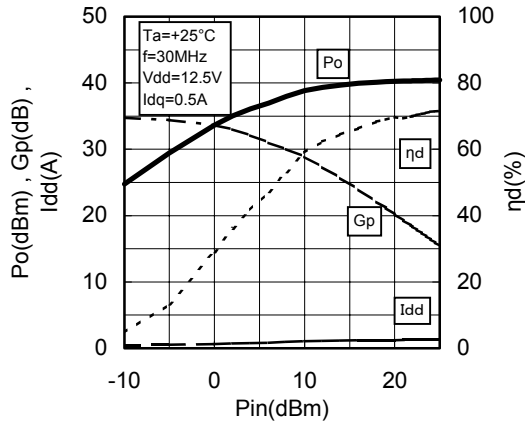

Pin-Po CHARACTERISTICS

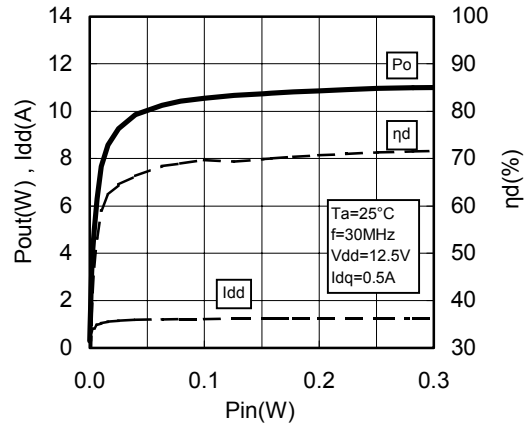

Vdd-Po CHARACTERISTICS

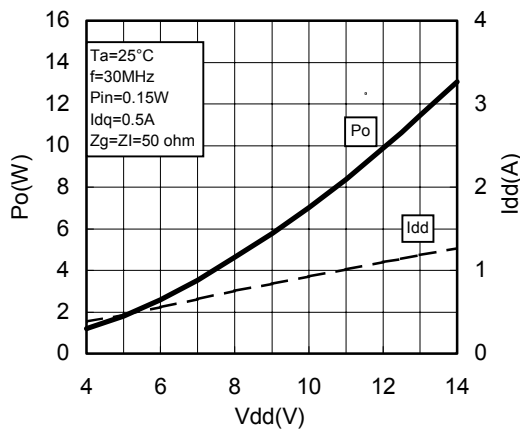

Vgs-Ids CHARACTERISTICS 2

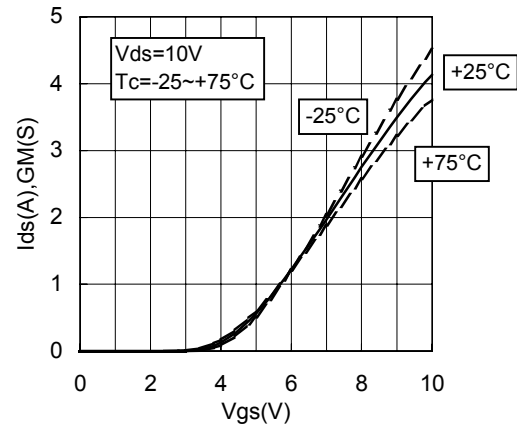

Vgs-gm CHARACTERISTICS

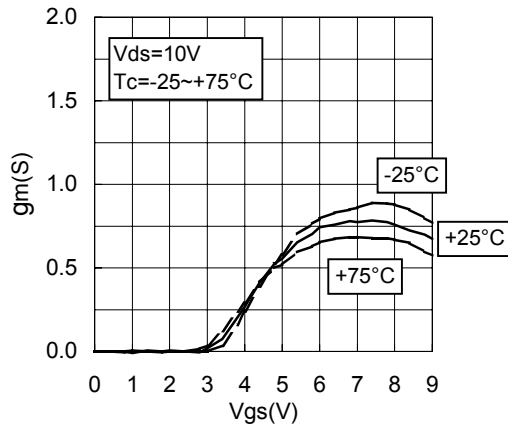



**ELECTROSTATIC SENSITIVE DEVICE**  
OBSERVE HANDLING PRECAUTIONS

**MITSUBISHI RF POWER MOS FET**

**RD06HHF1**

**Silicon MOSFET Power Transistor 30MHz,6W**

**TEST CIRCUIT(f=30MHz)**

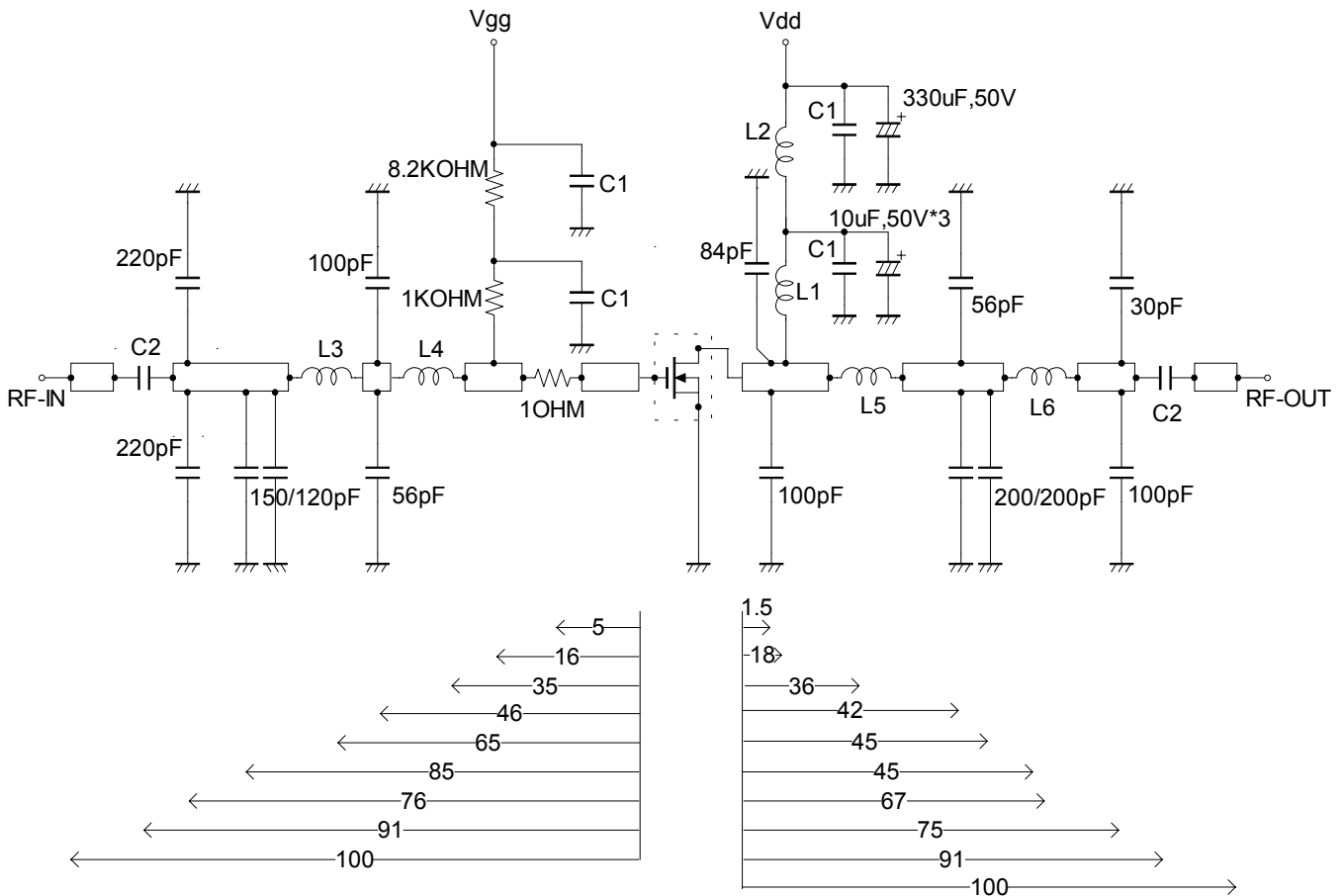

C1:100pF,0.022uF,0.1uF in parallel  
C2:470uF\*2 in parallel

L1:10Turns,I.D8mm,D0.9mm copper wire  
L2:10Turns,I.D6mm,D1.6mm silver plated copper wire  
L3:5Turns,I.D5.6mm,D0.9mm copper wire  
L4:6Turns,I.D5.6mm,D0.9mm copper wire  
L5:4Turns,I.D5.6mm,D0.9mm copper wire P=0.5mm  
L6:7Turns,I.D5.6mm,D0.9mm copper wire

Dimensions:mm  
Note:Board material- teflon substrate  
micro strip line width=4.2mm/50OHM,er:2.7,t=1.6mm



ELECTROSTATIC SENSITIVE DEVICE  
OBSERVE HANDLING PRECAUTIONS

MITSUBISHI RF POWER MOS FET

# RD06HHF1

Silicon MOSFET Power Transistor 30MHz,6W

## INPUT/OUTPUT IMPEDANCE VS.FREQUENCY CHARACTERISTICS

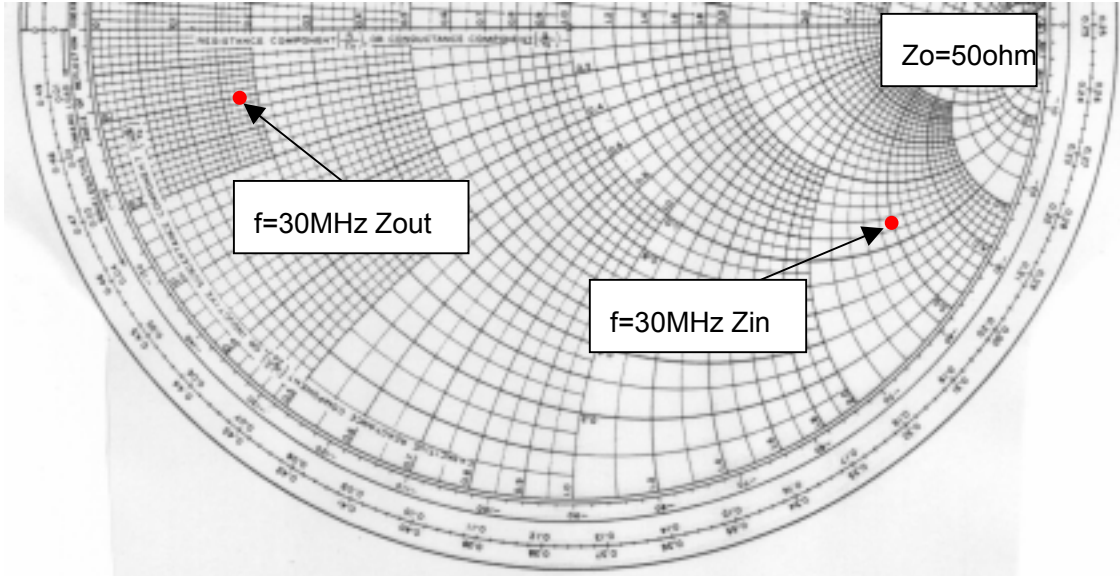

Zin , Zout

f	Zin	Zout	Conditions
(MHz)	(ohm)	(ohm)	
30	65.06-j150.9	8.75-j4.92	Po=10W, Vdd=12.5V,Pin=0.15W

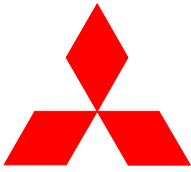

ELECTROSTATIC SENSITIVE DEVICE  
OBSERVE HANDLING PRECAUTIONS

MITSUBISHI RF POWER MOS FET

# RD06HHF1

Silicon MOSFET Power Transistor 30MHz,6W

RD06HHF1 S-PARAMETER DATA (@V<sub>dd</sub>=12.5V, I<sub>d</sub>=500mA)

Freq. [MHz]	S11		S21		S12		S22	
	(mag)	(ang)	(mag)	(ang)	(mag)	(ang)	(mag)	(ang)
10	0.985	-18.8	34.407	165.9	0.008	76.2	0.826	-17.3
30	0.900	-50.4	30.427	143.3	0.021	59.4	0.767	-43.6
50	0.799	-74.4	24.979	126.1	0.029	43.2	0.677	-65.0
100	0.667	-109.6	15.565	100.7	0.032	27.3	0.547	-96.8
150	0.636	-129.0	10.953	85.1	0.032	23.1	0.523	-113.4
200	0.630	-140.1	8.194	73.7	0.029	25.3	0.528	-124.7
250	0.645	-148.2	6.528	63.9	0.027	34.5	0.561	-132.7
300	0.663	-155.0	5.315	55.2	0.027	49.1	0.588	-139.6
350	0.685	-160.7	4.437	47.4	0.031	61.8	0.622	-145.9
400	0.708	-165.9	3.771	39.9	0.039	71.0	0.657	-151.7
450	0.729	-170.8	3.233	33.2	0.048	75.8	0.686	-157.0
500	0.752	-175.4	2.826	26.8	0.059	77.9	0.715	-162.3
550	0.771	179.9	2.475	20.7	0.070	76.9	0.743	-167.6
600	0.789	175.4	2.186	15.2	0.083	76.1	0.763	-172.3
650	0.804	171.2	1.943	9.7	0.095	73.7	0.789	-177.3
700	0.819	166.9	1.738	4.6	0.108	71.0	0.804	178.1
750	0.834	162.6	1.560	0.0	0.120	68.1	0.820	173.5
800	0.842	158.5	1.410	-4.5	0.133	65.0	0.837	169.0
850	0.851	154.3	1.275	-8.7	0.145	61.6	0.847	164.8
900	0.859	150.3	1.160	-12.6	0.157	58.2	0.858	160.2
950	0.866	146.2	1.058	-16.9	0.167	54.5	0.869	155.7
1000	0.870	142.3	0.963	-20.0	0.179	51.0	0.876	151.8



**ELECTROSTATIC SENSITIVE DEVICE**  
OBSERVE HANDLING PRECAUTIONS

MITSUBISHI RF POWER MOS FET

# RD06HHF1

Silicon MOSFET Power Transistor 30MHz,6W

---

—————Keep safety first in your circuit designs! —————

Mitsubishi Electric Corporation puts the maximum effort into making semiconductor products better and more reliable, but there is always the possibility that trouble may occur with them. Trouble with semiconductors may lead to personal injury, fire or property damage. Remember to give due consideration to safety when making your circuit designs, with appropriate measures such as (i) placement of substitutive, auxiliary circuits, (ii) use of non-flammable material or (iii) prevention against any malfunction or mishap.

————— **warning !** —————

Do not use the device at the exceeded the maximum rating condition. In case of plastic molded devices, the exceeded maximum rating condition may cause blowout, smoldering or catch fire of the molding resin due to extreme short current flow between the drain and the source of the device. These results causes in fire or injury.